

Designation system

- CT = Chip with three-layer- termination (Ag/Ni/Sn)
- 0402 = Dimensions of the device **04 x 02** (length x width in 1/100 inch)
- L = Tolerance of the varistor voltage ($\pm 20\%$)
- 4 = Maximum operating voltage (RMS voltage)
- G = Taped version (cardboard tape, 7" reel, 10000 pieces/reel)

Figure

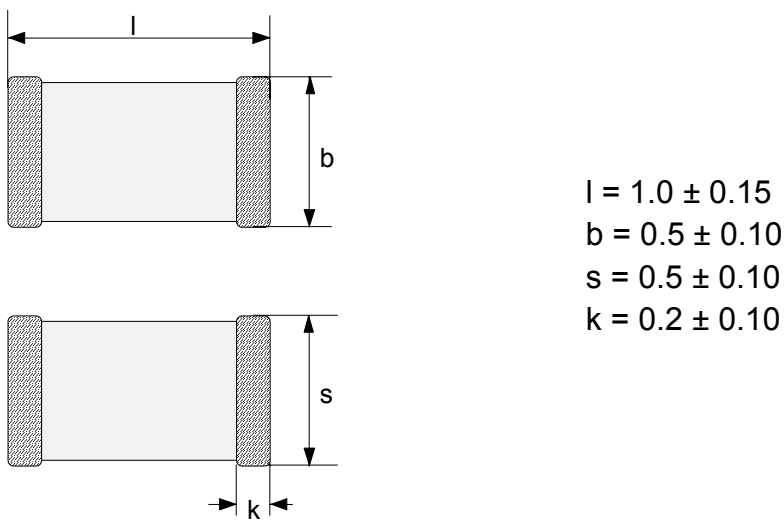

(all dimensions in mm)

As far as patents or other rights of third parties are concerned, liability is only assumed for components per se, not for applications, processes and circuits implemented within components or assemblies. The information describes the type of component and shall not be considered as assured characteristics. Terms of delivery and rights to change design reserved.

ISSUE DATE	28.01.2005	ISSUE	g	PUBLISHER	KB VS PE	PAGE	1/6
------------	------------	-------	---	-----------	----------	------	-----

V-I-characteristic

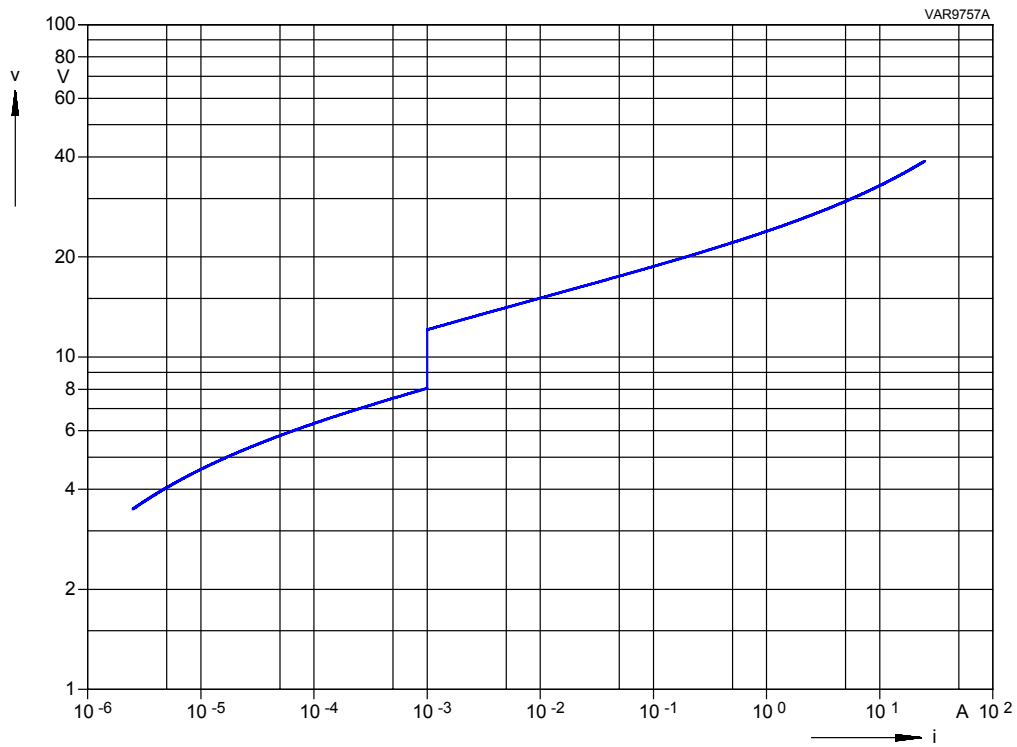

Derating field

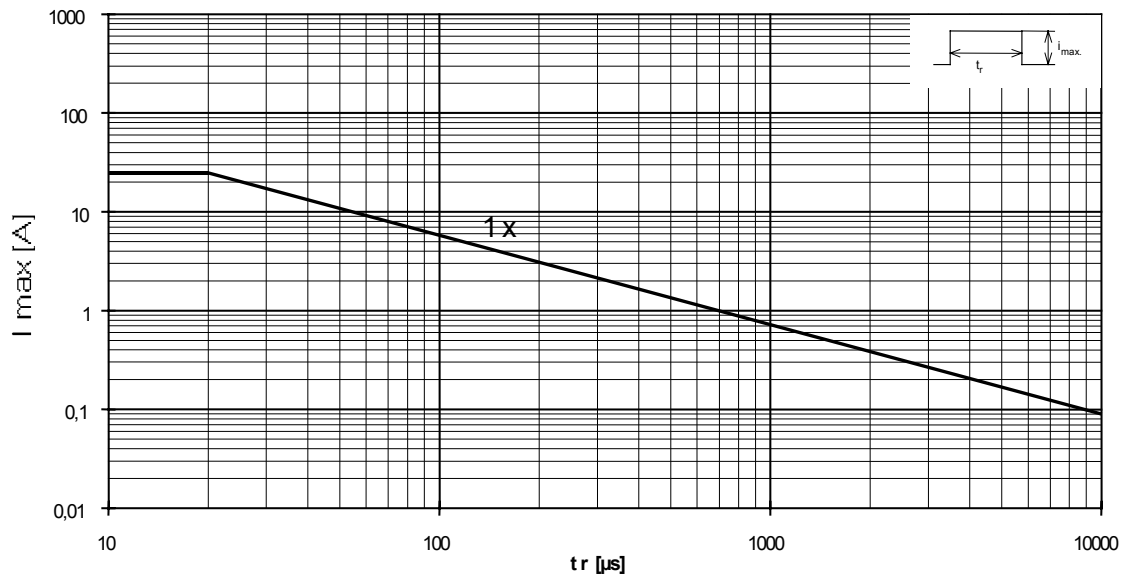

Electrical data

Maximum operating voltage

RMS voltage

$$V_{\text{RMS}} = 4 \text{ V}$$

DC voltage

$$V_{\text{DC}} = 5.5 \text{ V}$$

Varistor voltage (@ 1 mA)

$$V_V = 8 \text{ up to } 12 \text{ V}$$

Clamping voltage (@ 1 A, typical)

$$V_C = 19 \text{ V}$$

Maximum clamping voltage (@ 1 A)

$$V_C = 24 \text{ V}$$

Maximum average power dissipation

$$P_{\text{max}} = 3 \text{ mW}$$

Maximum surge current (8/20 μ s)

$$I_{\text{max}} = 1 \times 25 \text{ A}$$

Maximum energy absorption (2 ms)

$$E_{\text{max}} = 1 \times 17 \text{ mJ}$$

Capacitance (@ 1 kHz, 1 V, 25 °C, typical)

$$C = 200 \text{ pF}$$

Response time

$$< 0.5 \text{ ns}$$

Operating temperature

$$-40 \dots +85 \text{ }^\circ\text{C}$$

Storage temperature (mounted parts)

$$-40 \dots +125 \text{ }^\circ\text{C}$$

Termination material

$$\text{Ag/Ni/Sn}$$

(thickness not specified, adjusted to fulfil wettability specification according to **IEC 60068-2-58**)

Max. current, energy and average power dissipation depending on ambient temperature

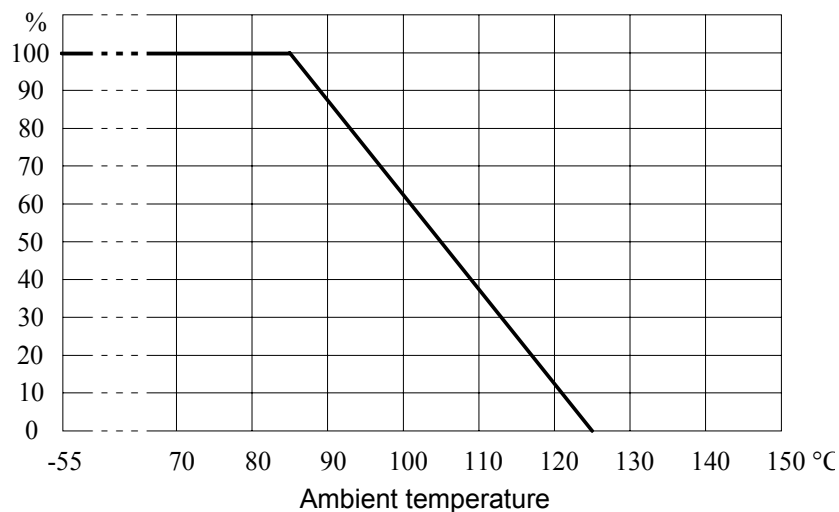

Recommended geometry of solder pad

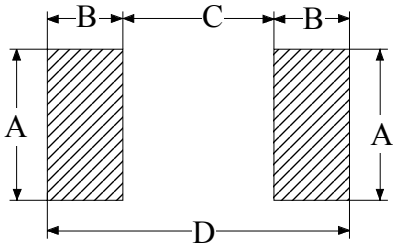

A = 0.6 mm
 B = 0.6 mm
 C = 0.5 mm
 E = 1.7 mm

Recommended soldering temperature profile

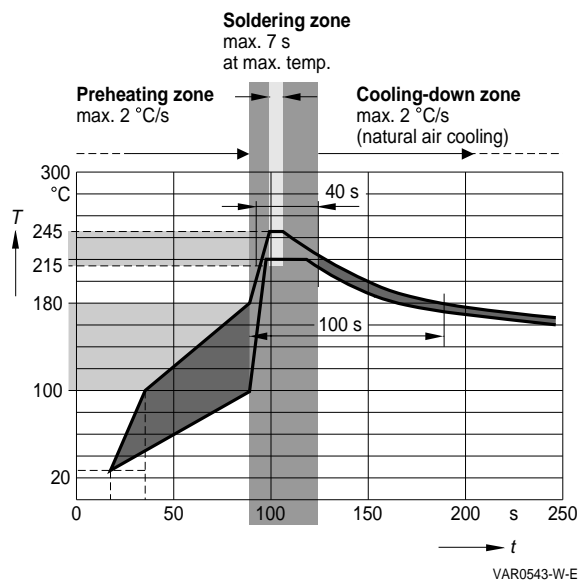

This component should be soldered within 12 months after delivery from EPCOS. They should be left in their original packings to avoid soldering problems due to oxidized terminals.
 Storage temperature: -25 to 45 °C
 Relative humidity: < 75% annual average, < 95% on maximum 30 days in a year.

The usage of mild non-activated fluxes for soldering is recommended, as well as proper cleaning of the PCB.

The components are suited for Pb-free soldering.

ISSUE DATE	28.01.2005	ISSUE	g	PUBLISHER	KB VS PE	PAGE	4/6
------------	------------	-------	---	-----------	----------	------	-----

Taping according to IEC 60286-3

Tape material: cardboard

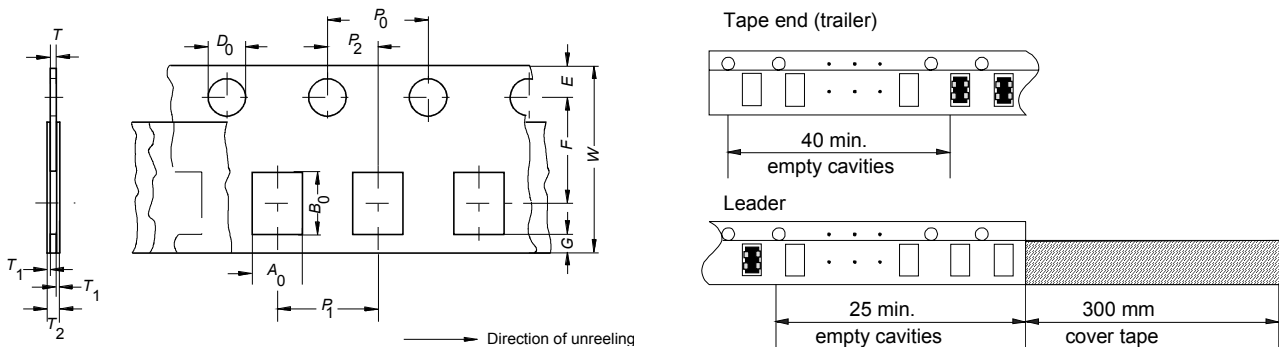

Dimensions and tolerances:

Definition	Symbol	Dimension [mm]	Tolerance [mm]
Compartment width	A_0	0.6	± 0.2
Compartment length	B_0	1.15	± 0.2
Sprocket hole diameter	D_0	1.5	$+0.1/-0$
Sprocket hole pitch	P_0	4.0	± 0.1 ¹⁾
Distance center hole to center compartment	P_2	2.0	± 0.05
Pitch of the component compartments	P_1	2.0	± 0.1
Tape width	W	8.0	± 0.3
Distance edge to center of hole	E	1.75	± 0.1
Distance center hole to center compartment	F	3.5	± 0.05
Distance compartment to edge	G	0.75	min.
Overall thickness	T_2	0.6	max.
Thickness of cardboard tape	T	0.3	max.

¹⁾ $\leq \pm 0.2$ mm over any 10 pitches

Packing

Reel material: plastic

Packing unit: 10000 pcs./reel

Reel dimensions:

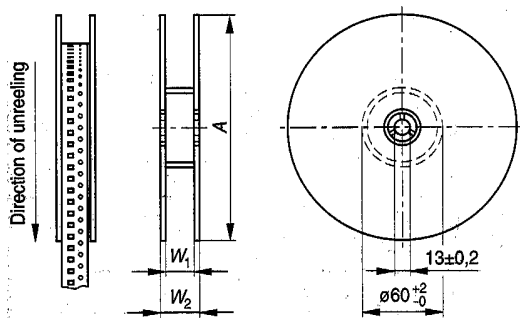

Definition	Symbol	Dimension [mm]	Tolerance [mm]
Reel diameter	A	180	+0/ -3
Reel width (inside)	W_1	8.4	+1.5/ -0
Reel width (outside)	W_2	14.4	max.

© EPCOS AG 2005. Reproduction, publication and dissemination of this data sheet, enclosures hereto and the information contained therein without EPCOS' prior express consent is prohibited.

Purchase orders are subject to the General Conditions for the Supply of Products and Services of the Electrical and Electronics Industry recommended by the ZVEI (German Electrical and Electronic Manufacturers' Association), unless otherwise agreed.

ISSUE DATE	28.01.2005	ISSUE	g	PUBLISHER	KB VS PE	PAGE	6/6
------------	------------	-------	---	-----------	----------	------	-----